

International Business Machines
Service Instructions
ITR 222
April 1, 1938

MASTER CLOCKS

Description

The Master Clock is, as the name implies, master of the electric clock system. It is the controlling time piece for the system and its time is transmitted to all secondary apparatus by means of wires and electromagnets. Each master clock is fitted with a circuit closer called an impulse contact. The impulse contact usually closes once each minute.

The master clocks are made with two types of drive, i.e., spring and weight driven. The principle of operation, adjustments, installation and maintenance is described as follows.

Weight Driven

The International, weight-driven, motor-wound Master Clock is the highest type of commercial time piece manufactured. The driving power is furnished by two weights which insure constant and even power to the escape wheel at all times. Differential gears are used to furnish power to the escape wheel while the clock is winding. Ball bearings are placed at all points of heavy pressure and jewel cut pivots at the remainder, reducing friction to a minimum. The movement of the weights is controlled by an automatic switch which cuts in the motor when the weights have run down a certain distance and cuts it out when the clock is fully rewound. If power is not available when the switch is turned on the circuit remains closed until power is restored and the weights are raised to a point where the switch turns off.

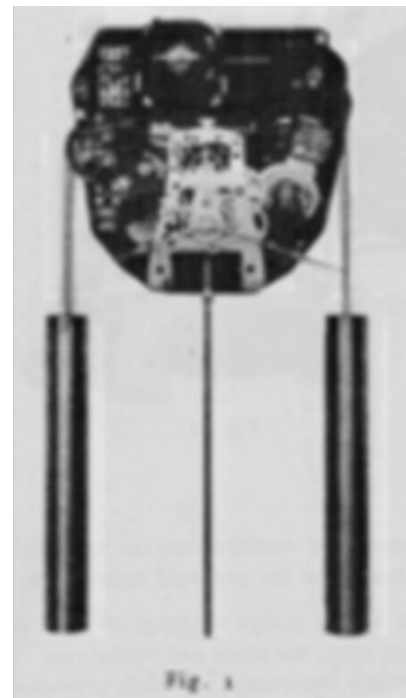

Spring Driven

The International, spring-driven, minute wound Master Clock is a very high grade clock and will meet the most exacting commercial requirements. The driving power is furnished by a flat spring which has reserve power of 8 to 12 hours depending on the contact load.

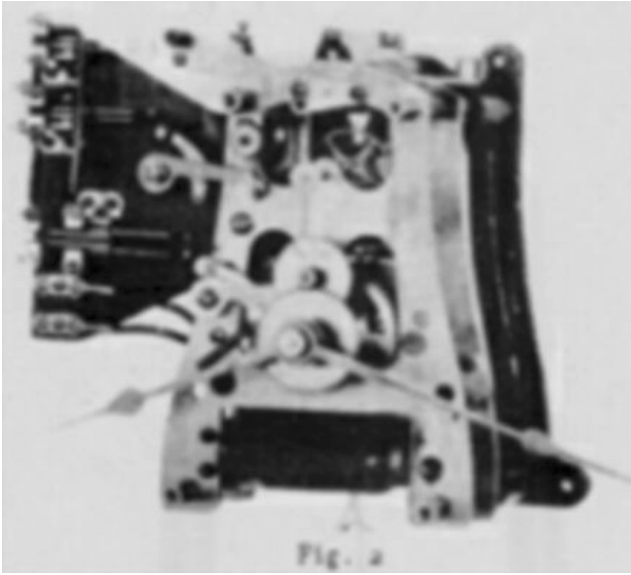

Installation

In order to secure the maximum results from this Master Clock it should be carefully installed and properly maintained.

The Master Clock should always be installed on a substantial post or wall that is free from dust, moisture and vibration. Its location as a time piece is of secondary importance. Special treatment is used in manufacturing to prevent oxidation of the gears and other working parts, but a clean, dry place for the clock is almost essential to prevent oxidation, regardless of the treatment during manufacture.

The usual practice is to place the top of the Master Clock approximately eight feet from the floor. This locates the hands within easy reach for setting and the pendulum in a convenient position for regulation. However, local conditions may necessitate placing the Master Clock at a different height. (See Fig. 3).

The Master Clock should be securely attached to the wall so that it will not move out of plumb even with a severe jolt. If the Master Clock is moved only slightly, it will throw it out of beat and thus effect its timekeeping, and may even stop it. The Master Clock is designed to be attached at four points, viz.: (1) The hanger, which may be a large screw in the wall, or the special International wall box for Master Clocks. This screw or bolt in the wall box is the main support for the weight of the Master Clock. (2) One screw is provided for the bottom center of the case. This prevents side sway of the bottom of the case and keeps the clock in beat. (3 and 4) Two screws are provided for the top of the case at the sides of the dial. These screws prevent rolling on an uneven wall and hold the case rigidly against the wall.

When control and program equipment is mounted in the Master Clock case, some unit may be mounted directly over the screw hole and will have to be removed before the Master Clock can be properly attached to the wall.

The wall upon which the Master Clock is to be mounted should be perpendicular and true. If not,

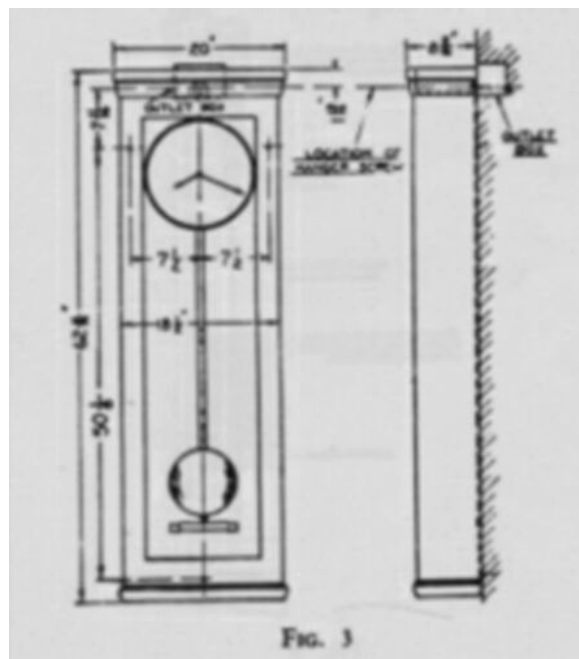

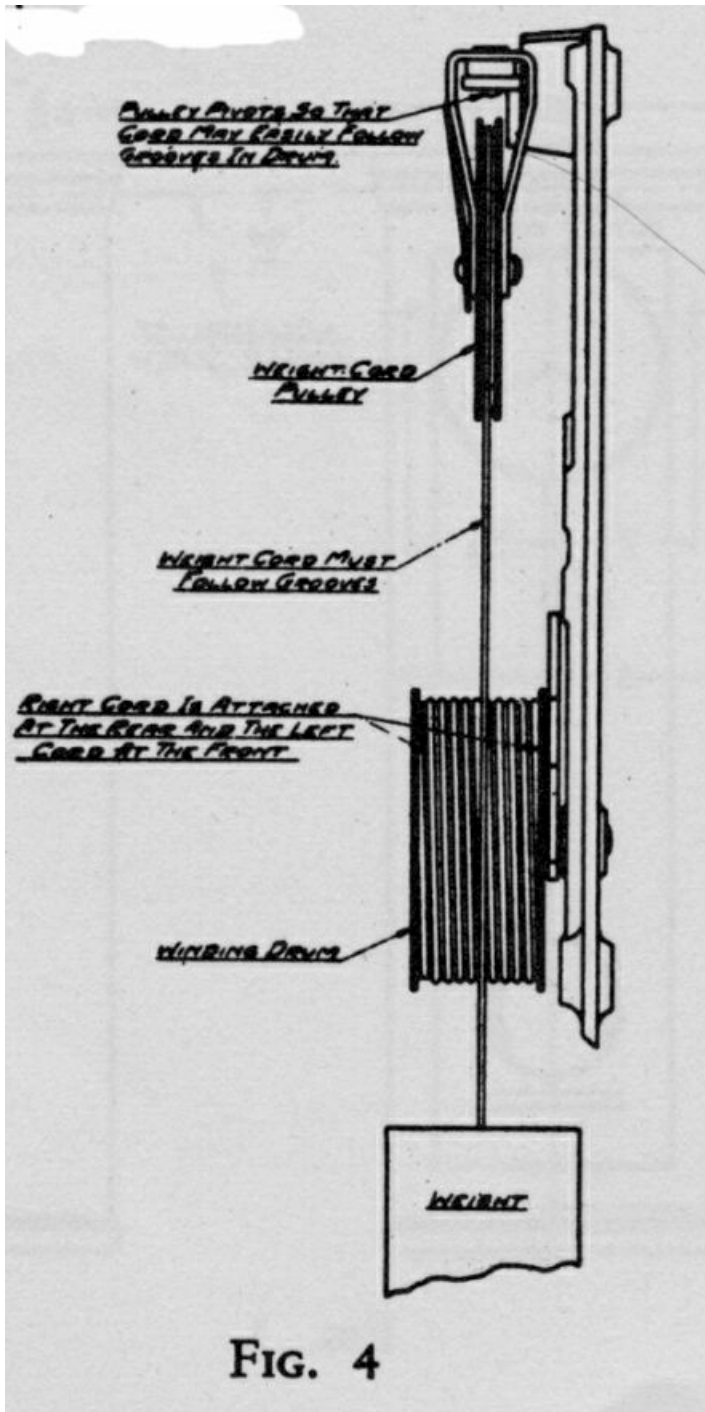

care should be taken not to tighten the screws until the case is twisted, but block out the case where necessary.

It is advisable to use the pendulum as a plumb before installing any except the top or hanger screw. The end of the pendulum screw should hang directly over the "0" position of the scale, and neither in front of nor behind the scale. (See preceding instructions for installing pendulum).

Installing Weights

The weights may be installed after the case is securely attached to the wall. The clock is shipped wound up and the weight cords are properly wound around the drum and then tied. Extreme care should be used to see that they do not loosen and become crossed on the drum, as this will rob the movement of its power. (See Fig. 4). The weight cords are attached to the weights with nuts that have standard, right-hand threads. They should be screwed all the way in and then tightened. Do not touch the weights with the bare hands as it may discolor them. Use tissue paper or a cloth for handling the weights.

INSTALLING PENDULUM

If the pendulum is of the lenticular brass bob type it is shipped with the bob removed from the pendulum stick. Insert the rod in the bob, with the hook on the top of the rod pointing to the lead side of the bob, and screw up on the nut that supports the bob until the top of the bob coincides with the pencil mark on the pendulum stick. A slot is cut in the back of the pendulum bob into

which the top portion of the regulating nut fits. This construction prevents the possibility of friction holding the pendulum bob so that it will not follow the nut when regulating the clock to run slower.

The mercurial compensating pendulum is shipped completely assembled. If the pendulum does not hang so that the crossbars are square with the case, loosen set screw in friction guide assembly (just under top crossbar) and turn jar frame until jar frame is square with case. Re-tighten set screw.

The Invar Pendulum is shipped with the heavy bob removed. To install remove the free running nut and screw the rod in the bob until there is a clearance of $1/16''$ between the knurled knob on the rod and top of bob. The free running nut should then be screwed on the rod, small end down, until it is approximately $1/8''$ below the bottom of the bob.

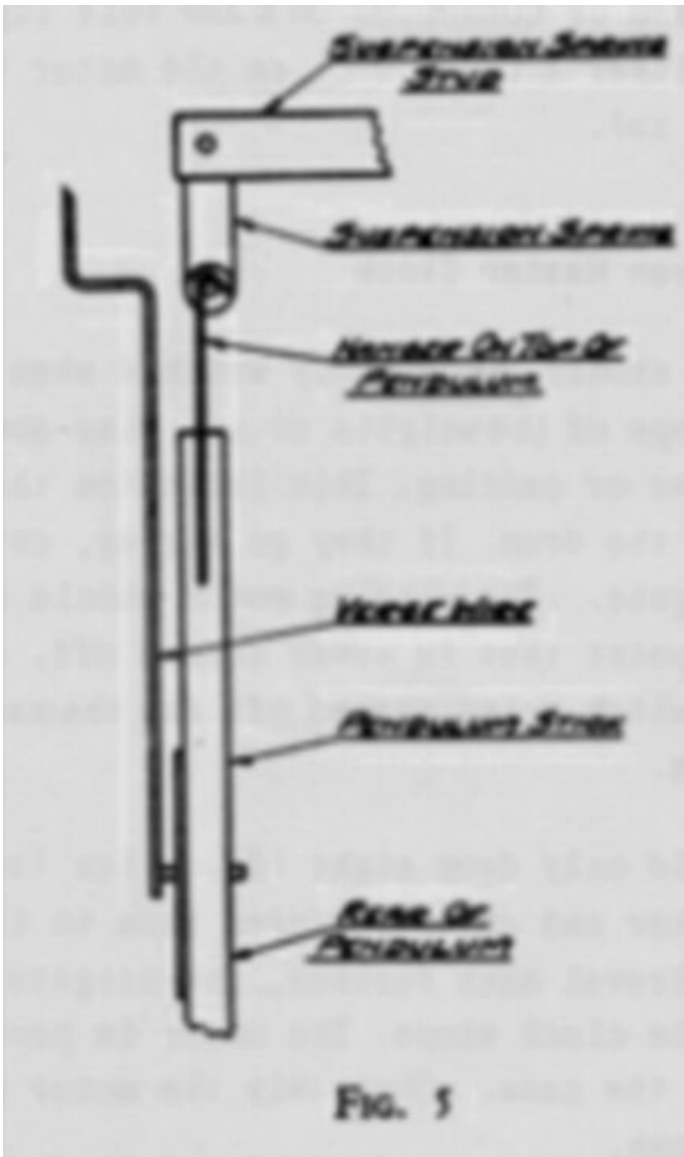

Extreme care should be taken not to kink or crack the suspension spring while installing the pendulum. The suspension spring is located almost directly back of the seconds hand shaft. The hook on the top of the pendulum rod may be easily placed over the suspension spring pin by inserting the top of the rod up between the back plate of the clock movement and the back casting. After the pendulum is properly supported, adjust the verge wire to the pendulum. On the lenticular brass bob pendulum, the verge wire fits on a slot on the pendulum stick. On the mercurial pendulum, the verge wire straddles the pendulum rod.

Connecting Master Clock

The Master Clock must be connected to the system according to the wiring diagram which accompanies the system; that is, all terminals should be connected to the correspondingly marked terminals of the master relay cabinet, etc., and the motor terminals to the commercial current, 110 volts; unless an external resistance is mounted on top of the master clock cabinet, in which case it should be connected to a 220 volt

lighting service. The winding power may be either A.C. or D.C. as the motor is of the universal type. (See Fig. 11 & 12).

Winding of Weight Driven Master Clock

The Master Clock should be closely watched when winding the first time to see that the tops of the weights do not rise above the lower screw holes in the back frame or casting. This indicates that the weight cords are wound properly on the drum. If they go higher, cut off the power immediately and investigate. The winding motor should always be connected to the power at some point that is never turned off, as there is always the possibility of a switch being turned off and the master clock stopping because it is run down.

The weights should only drop eight or ten inches before the switch cuts in the motor and again restores them to their original position. If the weights travel much further, investigate and see that power is available before the clock stops. The motor is protected by two fuses located on the top of the case. Obviously the motor will not operate if either of these is blown.

Winding of Spring Driven Master Clock

The Master Clock is spring driven and winds with an electromagnet at each impulse. A unique reverse winding mechanism insures constant tension and prevents overwinding. The principle of winding will be very easily understood by studying Figure 6, and the following description of the individual parts.

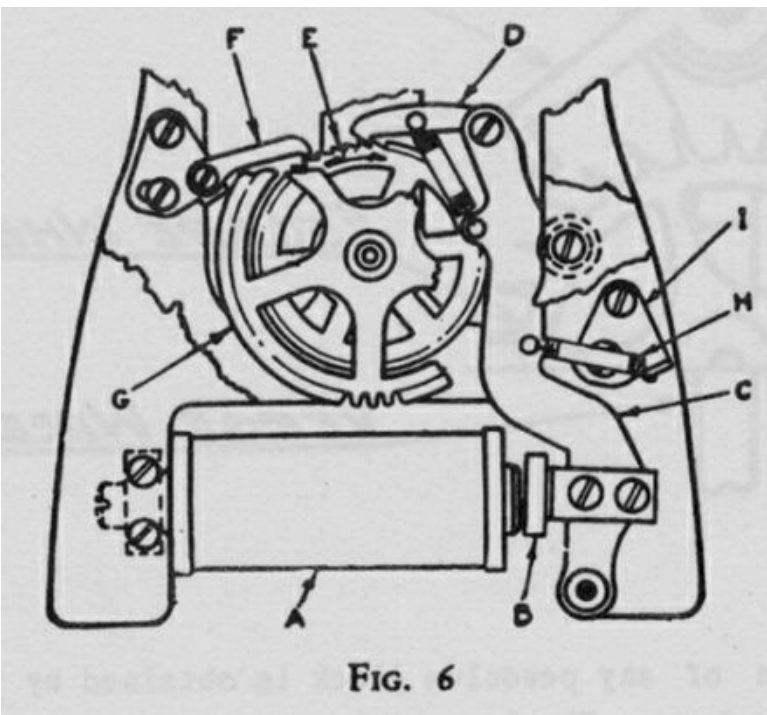

- A. Electromagnet.
- B. Electromagnet armature attracted each impulse.
- C. Lever attached to armature, advances feed pawl (D).
- D. Feed pawl, moves ratchet (E) one tooth each impulse.
- E. Winding ratchet.
- F. Detent pawl, hold ratchet (E) from turning backwards.
- G. Main driving gear.
- H. Winding spring, the tension of which balances through the tension of the main driving spring attached to winding ratchet (E) and main driving gear (G).
- I. Adjustment for tension of winding spring (H).

Checking Beat of Clock

If the clock does not tick even, or if the seconds hand hesitates longer on one second than another, the clock is out of beat. The best method of accurately checking a pendulum clock to see if it is in beat is to watch the movement of the seconds hand when the pendulum is moved slowly by hand. The seconds hand should advance on any second when the pendulum is an equal distance each side of zero on the pendulum scale. In other words, the seconds hand should not be released when the pendulum is at 11 on one side of zero and 1 1/2 on the other side. It is understood that the pendulum is exactly at zero when at rest. If the clock is out of beat, it may be adjusted by turning the small, knurled, thumb screws located on the verge which is above and just in front of the upper end of the pendulum. (See Fig. 7). If putting clock in beat is not thoroughly understood, it is advisable to call an International serviceman.

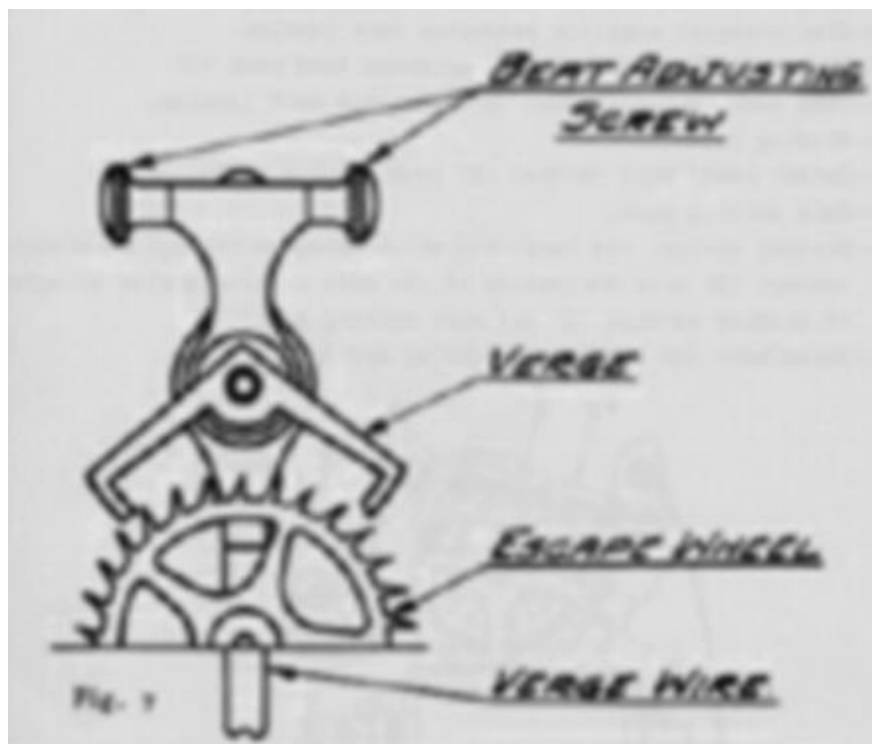

Regulating

The regulation of any pendulum clock is obtained by lengthening or shortening the pendulum. The longer the pendulum the slower the clock will run and vice versa. On lenticular brass bob pendulum clocks, one complete turn of the nut which supports the pendulum bob will cause a variation of approximately one minute per day. The screw on the pendulum rod is a standard right hand thread. Turning the nut to the right shortens the pendulum and vice versa.

Clocks equipped with mercurial compensating pendulums have two regulating mediums, each of which is graduated for two standard time regulations.

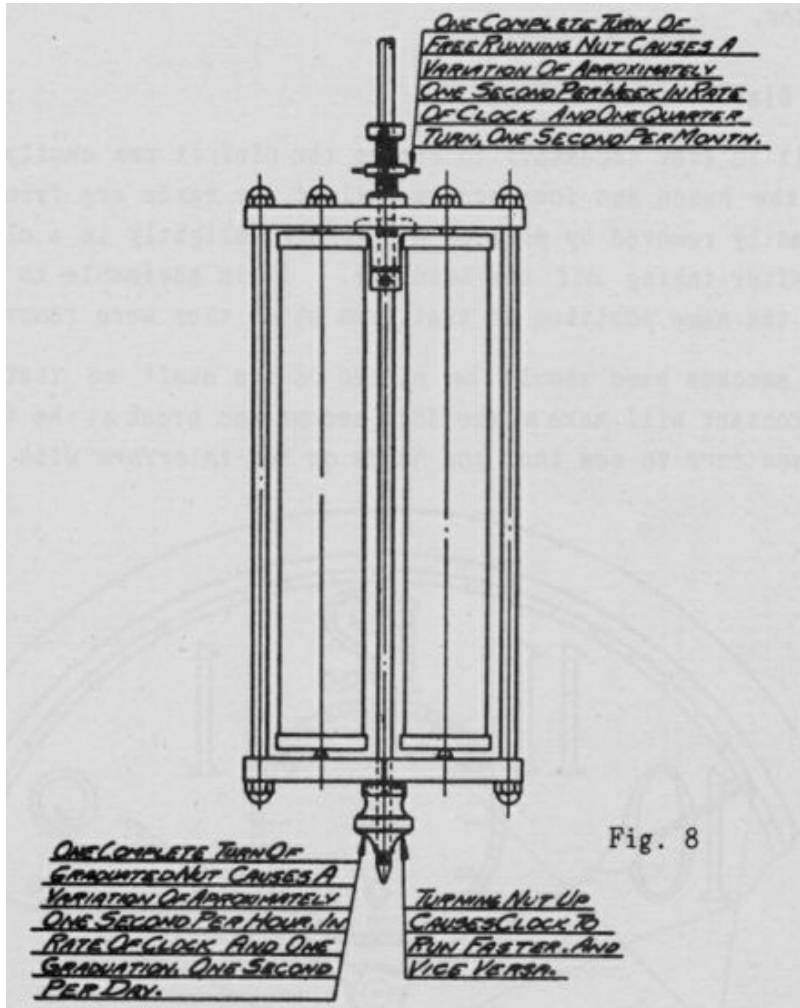

The nut upon which the pendulum jars rest is for coarse regulation and one complete turn varies the rate of the clock approximately one second per hour and one division varies the rate of the clock approximately one second per day. The free running nut (located at lower end of rod) is used for fine regulation only. One complete turn causes a variation in the rate of approximately one second per week and one quarter turn a variation of approximately one second per month.

Setting Master Clock

Never turn the clock hands backwards nor move the hour or seconds hand. If the Master Clock is fast, stop the pendulum and then start again when it is at the exact time.

If the Master Clock is slow, stop the pendulum just after any minute as indicated by the seconds hand. Move the minute hand until it is over the minute marker and so the Master Clock is just ahead of correct time, then start pendulum swinging again at the correct instant. Note that when the seconds hand points to 60 the minute hand points directly at a minute marker. (See Fig. 9). This is important as some cams are timed with the seconds hand and others with the minute hand. The hourly supervising feature takes care of setting the secondary units to correct time.

Never move the hour hand on a master clock equipped with an impulse accumulator.

Removing Dial

If it is ever necessary to remove the dial; it can easily be done by removing the hands and four screws. All of the hands are friction fit and may be easily removed by pulling and turning slightly in a clockwise direction after taking off the hand nut. It is advisable to replace the hands in the same position as that from which they were removed.

The seconds hand should be placed on its shaft so that the minute impulse contact will make at the 58th second and break at the 60th second. *Use extreme care to see that the hands do not interfere with each other.*

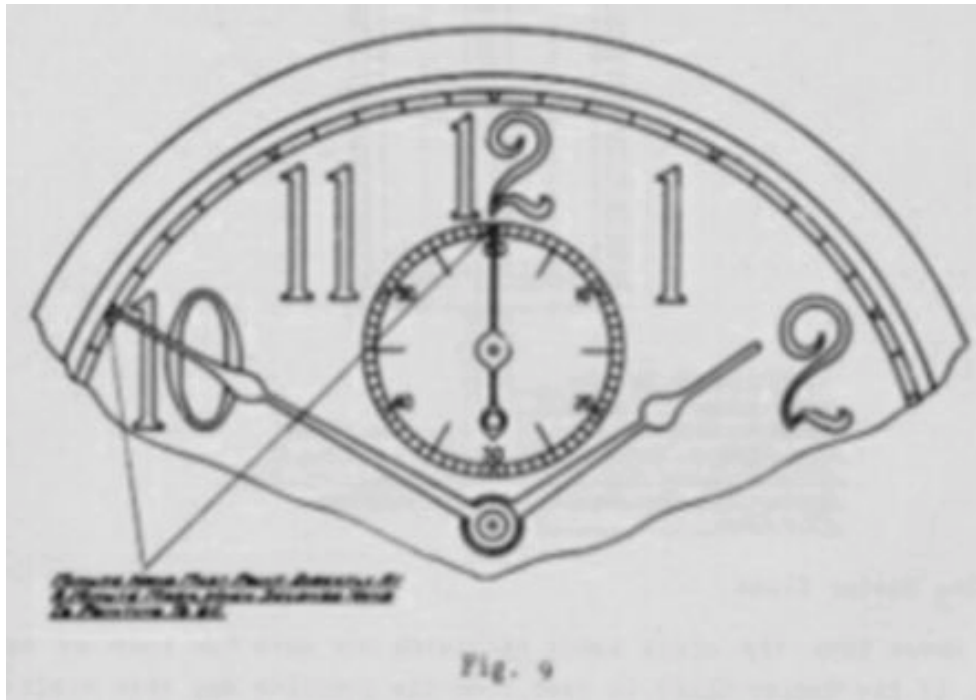

Contacts and Switches

As stated in the instruction covering the hourly supervised system, the Master Clock is equipped with the necessary contacts and switches for sending out the minute impulses and for supervising the secondary units. (See Fig. 10). It may also be equipped with a duration contact for controlling the duration of signals such as bells, horns, etc.

The minute impulse contact is operated from a cam placed on an auxiliary shaft used solely for contact purposes and located to the left of the escape wheel. This contact makes for a period of two seconds each minute. It is timed to make on the 58th second and break on the 60th second of each minute. The contact has a positive make and break, and when properly adjusted, the upper contact strap should be lifted $1/64''$ above its normal position when the contact is made. This contact is properly adjusted at the factory and will not need changing.

The rapid impulse contact makes every two seconds and is controlled by the swinging of the pendulum, that is, the contact operating lever is attached to the verge shaft and rocks when the pendulum swings. This contact has a positive make and is open when the pendulum is at rest. This contact alone does not have any effect upon the system, but working in conjunction with the advance switch, sends out the rapid impulses.

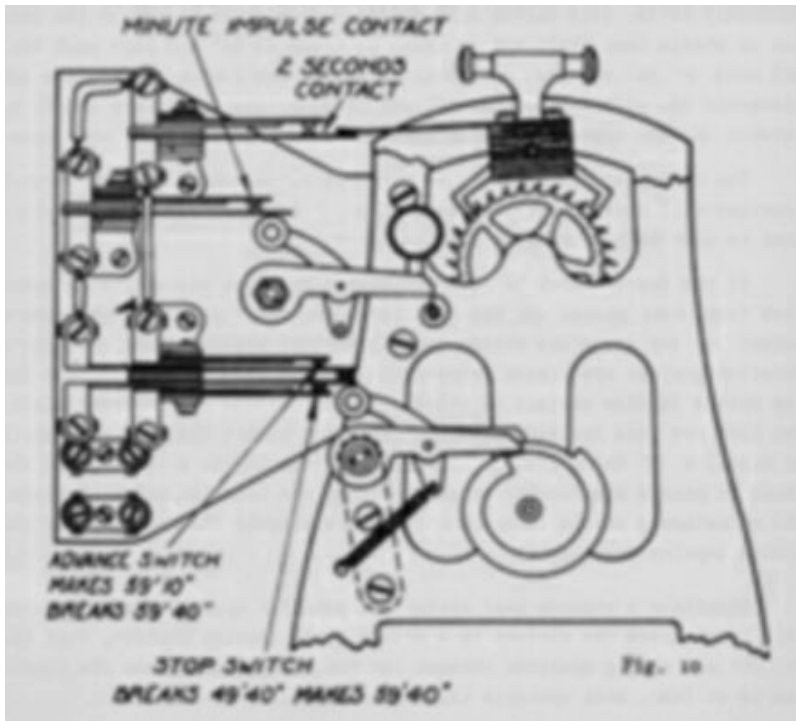

The advance switch is connected in series with the two seconds contact and thus controls the operation of the latter. The advance switch is operated from a cam placed on the center or minute hand shaft. This cam makes one revolution each hour and is cut so as to operate the advance switch once an hour, viz., closes same at 59' 10" past the hour and opens it at 59' 50" past the hour. The switch only remains made for 40 seconds each hour, therefore, allows only 20 of the two seconds or rapid impulses to be sent out to the system. The upper strap

should be raised 1/64" above its normal position when made, and it also should have a quick break. This switch is properly timed and adjusted at the factory and should not be changed.

The stop switch is used to open the circuit to prevent the impulses from going out over the "B" wire to the secondary units between 49' 10" and 59' 50" past each hour. It is much heavier than the other switches, as it carries the current but does not break the circuit to the master circuit which controls the distribution relays or a single circuit of secondary units. This switch also operates from a cam placed on the center or minute hand shaft, and is timed to break at 49' 10" past each hour and make at 59' 50" past each hour. It is very important that the adjustments are such that a good contact is made; that is, there should be tension on the upper strap when made and also a good air gap when open.

The timing of the switches is not critical as 18 or 22 of the rapid impulses will serve equally as well as 20. However, the advance switch must be open before the stop switch closes.

If the Master Clock is equipped with a duration contact, it is operated from cams placed on the auxiliary cam shaft and normally makes a second or two after the minute impulse contact breaks. The cams for a duration contact are placed between the clock plates, whereas the cam for the minute impulse contact is placed on the outside of the front plate. Two cams are used for each duration contact to permit changing the length of duration of the signals. Turning the cams on the shaft so that the faces or points are farther apart increases the duration, and vice versa. The adjustments of the duration contact are exactly the same as for the minute impulse contact.

Sometimes a seconds beat contact is used for special purposes. When this is the case, the contact is a double rapid impulse contact, that is, one contact spring operates between two contact points. When the pendulum is at rest, both contacts should be open.

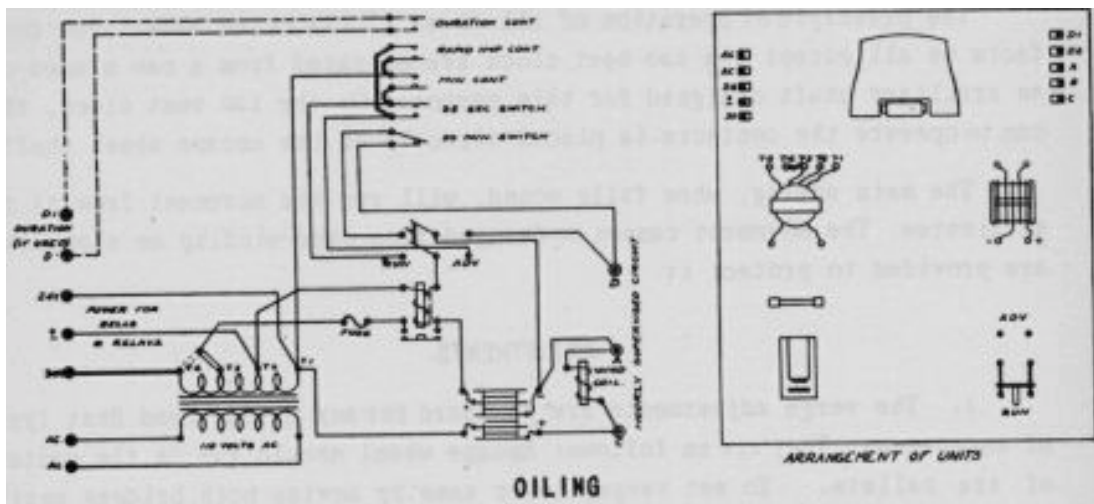
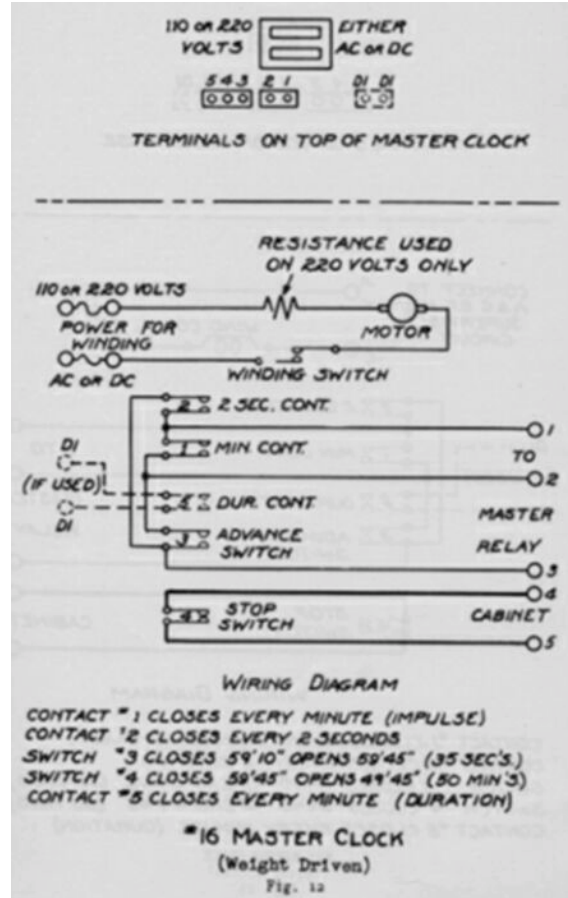
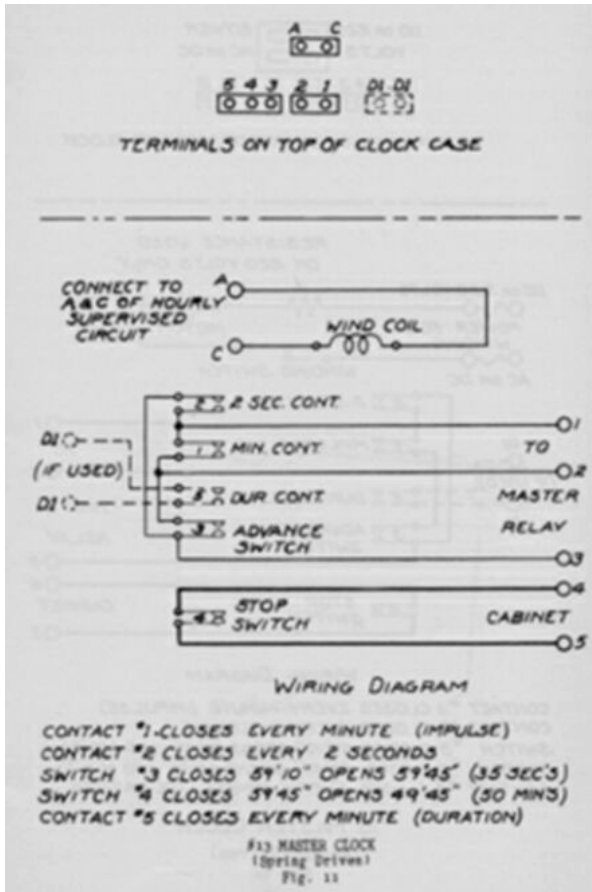

The oiling of the Master Clock is very important. It does not need frequent oiling, but when it does need oiling, it should be done properly. The pallets and all bearings should be oiled, the gear teeth never. Too much oil is more harmful than not enough. Only a good grade of clock oil should be used, such as can be obtained from any clock and watch makers' jobbers. Enough oil for each bearing can be applied by means of a wire, the size of a common pin, dipped into a reservoir to the depth of about a quarter of an inch.

Old Style Spring Driven Master Clocks

The driving power for these Master Clocks is derived from a small helical spring which, at all times, is kept wound to even tension by an electromagnet and ratchet mechanism. When the minute impulse contacts close, they cause an electric circuit to be completed. This electric circuit energizes the coils of the electromagnet and its armature is attracted. When the armature is attracted, a pawl attached to the armature engages the ratchet and winds the clock.

The winding ratchet is located on the center or minute hand shaft. The main spring is also on this shaft. Power is transmitted from this shaft through the train gears to the escape wheel.

The Graham Dead Beat type of escapement, consisting of brass escape wheel and hardened steel verge, is used as it is considered best suited for this type of clock movement.

The magnet wound spring driven Master Clocks are made for three different sizes, i.e., 60, 72 and 120 beat pendulums.

The principle of operation of all these clocks is the same. The contacts on all except the 120 beat clock are operated from a cam placed on an auxiliary shaft designed for this purpose. On the 120 beat clock, the cam to operate the contacts is placed directly on the escape wheel shaft.

The main spring, when fully wound, will run the movement from 51 to 53 minutes. The movement cannot be damaged from over-winding as stop pins are provided to protect it.

ADJUSTMENTS

1. The verge adjustments are standard for any Graham Dead Beat type of escapement. They are as follows: Escape wheel should run on the center of the pallets. To set verge, lower same by moving both bridges until escape wheel will not escape. Then raise in the same manner until the escape wheel teeth just clear throughout the circumference. This insures that the verge is set as low as possible without hitting on the escape wheel teeth and also that the verge shaft is in a horizontal plane. Under no condition must the verge bottom on the escape wheel. Adjusting screws are provided on all master clocks except the 120 beat for putting them in beat.

2. Liner must fit snugly against armature.

3. Armature must strike both poles evenly.

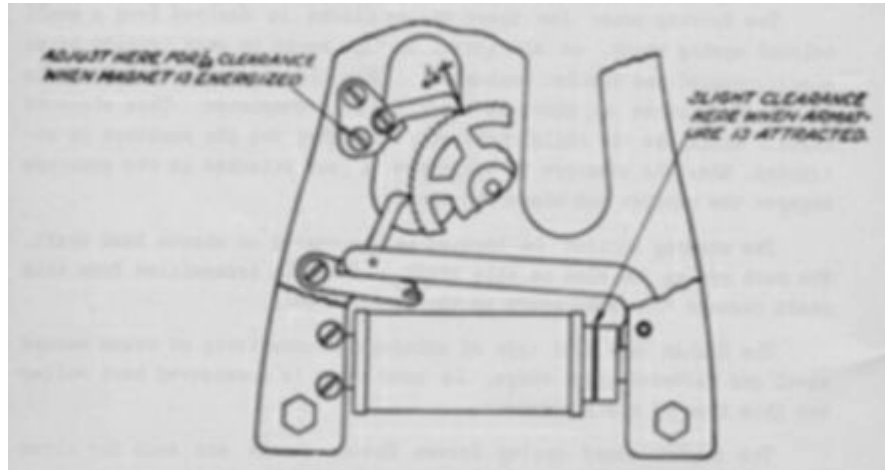

4. Adjust the armature and magnets for .003" clearance at the top of the armature when attracted.
5. With the armature attracted, adjust the retaining pawl for a slight clearance between the pawl and the ratchet tooth. This insures the retaining pawl dropping into the ratchet and holding same each time it is moved forward.
6. Adjust armature lever return stop so that the feeding pawl will overlap the ratchet tooth 2/3 of a tooth when in a de-energized position.
7. Adjust armature return spring for satisfactory operation on a 25% drop in voltage.

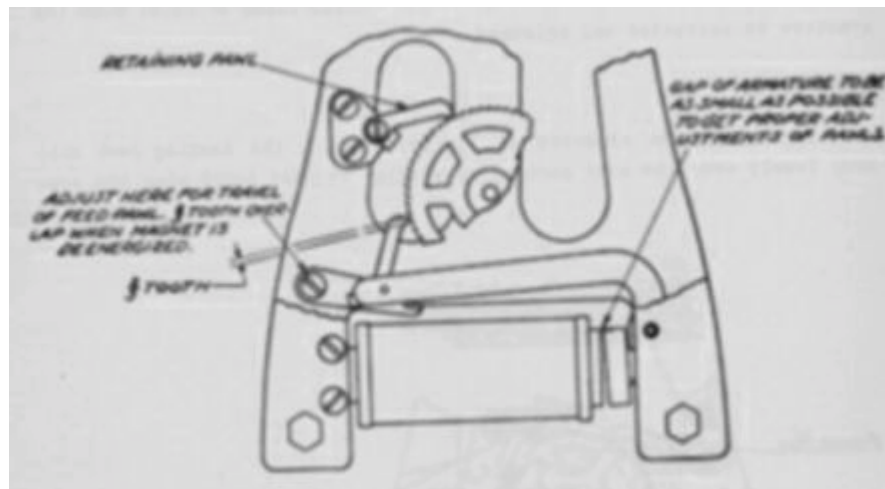

Master Clock Winding Mechanism

The winding mechanism of all electromagnet wound master clocks operates so that the clock is wound when the electromagnet releases its armature. When the armature is attracted tension is placed on a coil spring. At the end of the impulse to the electromagnet the coil spring returns the armature to its de-energized position.

A pawl is attached to the armature by means of a lever. When the armature is attracted the pawl drops over the next succeeding tooth in the ratchet. When the armature is released the armature return spring restores the pawl to its original position and advances the winding ratchet one tooth.

The winding ratchet has 59 teeth. The winding electromagnet is connected to the A and C wires of the self regulating systems, therefore, receives all of the impulses. The anchor posts for the main spring are shorter than before. This allows them to pass and the main spring to have maximum tension at all times. No harm is done the ratchet and pawl if the winding electromagnet receives more impulses than necessary as the armature return spring pulls against the main spring. As the clock becomes fully wound the difference in power of the two springs gradually decreases until it reaches a point where the power of each is equal and the clock does not wind. The winding operation is much smoother than before as the spring cushions the impact which tends to occur when the armature is attracted and released.

Adjustments

1. Adjust the armature on its lever until the feeding pawl will drop freely over the next succeeding winding ratchet tooth when the armature is held against the cores by hand. It is important that the armature strike the pole faces squarely.

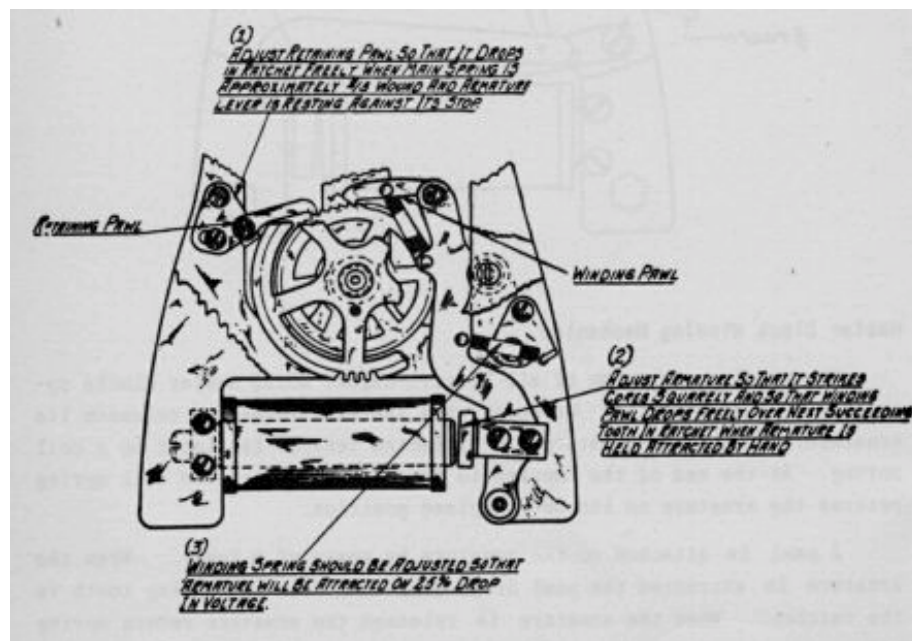

2. Adjust the retaining pawl until it drops freely in the ratchet when the armature is released and the armature lever rests against its stop. Both of the above adjustments are independent upon each other and should be made when the clock is approximately 2/3 fully wound.

When winding the master clock by hand attract the armature and let it release under its own spring power. Do not pull or force the lever against its stop.

Contact Adjustments

1. Adjust the minute impulse contact for two seconds duration on all clocks except the 120 beat. On the 120 beat, adjust for 1/2 second duration. This adjustment is made by moving the eccentric bushing at the pivot point.
2. Adjust the stop for the contact fingers so that they will not bottom on the cam.
3. Contacts should have 1/32" air gap when broken.
4. Upper contact should have 1/64" tension when made.

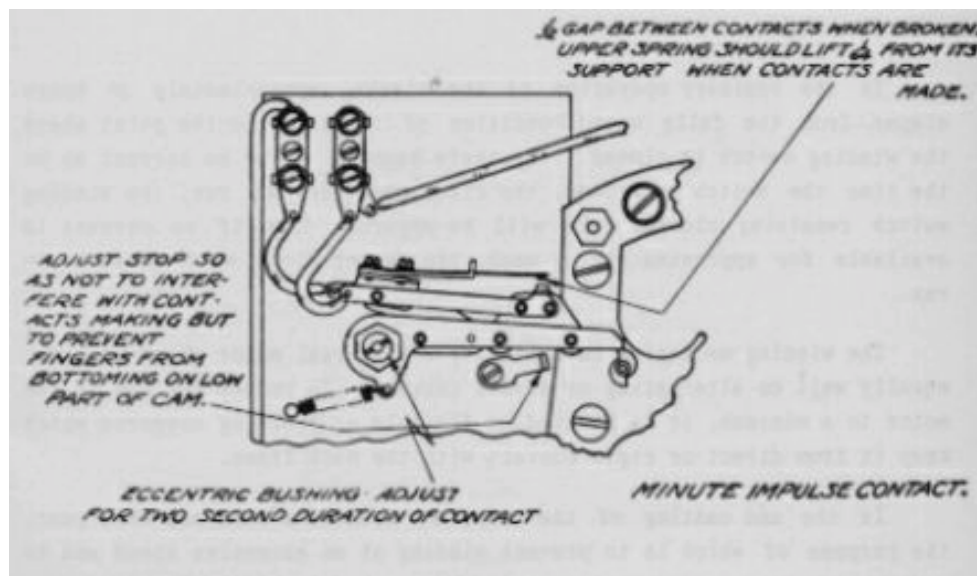

Any Master Clock may be equipped with a duration contact which is operated from cams placed on the auxiliary shaft between the clock plates. The adjustments are standard except for the length of duration which may be varied to suit any special requirement. If the desired length of contact cannot be obtained by adjusting the eccentric bushing, the cams may be shifted changing the relation of the dropping off points.

WEIGHT DRIVEN MASTER CLOCKS

All of our Weight Driven Master Clocks are motor wound. The mechanism consists of two main parts; the clock movement itself and the back frame or casting upon which is mounted the motor for winding, the gearing immediately connected to it, the drum for carrying the cables to which the weights are attached and the switch for cutting the motor in and out of the circuit. The movement can easily be removed from the back frame by locking the weights with the pawl provided and removing the four screws.

The mechanism is so arranged that the clock will run between eight and nine days from the time it is fully wound to the time when the weights reach the bottom of the case. The above statement covers the condition when a mercurial pendulum is used. Owing to the greater diameter of the metal ball pendulum and its greater swing, it is necessary to shorten the drop of the weights and the full capacity of the run is then a little over five days.

In the ordinary operation of the clocks, approximately 30 hours elapse from the fully wound condition of the clock to the point where the winding switch is closed. If there happens to be no current on at the time the switch is closed, the clock continues to run, the winding switch remaining closed. It will be apparent that if no current is available for approximately a week, the Master Clock will continue to run.

The winding mechanism is driven by a universal motor which will run equally well on alternating or direct current. To reduce the hum of the motor to a minimum, it is mounted on flexible or yielding supports which keep it from direct or rigid contact with the back frame.

In the end casting of the motor is mounted a worm and worm gear, the purpose of which is to prevent winding at an excessive speed and to form a positive lock to prevent the weights from turning the motor armature backward when not winding.

The motor is connected to the winding drum by means of a fiber coupling. Differential gears are placed in the winding drum to insure power to the escape wheel while the clock is winding. The power from the downward pull of the weights is transmitted through these differential gears to the main driving gear and thence through the usual train of gears to the escapement.

To make the clock as near frictionless as possible, the winding drum and main gear are equipped with ball bearings.

The winding switch is so designed that the weights cannot rise beyond a certain point without opening the switch even though the switch may be out of adjustment so that it will not snap open. There is an eccentric screw in the switch arm which permits the switching mechanism to be adjusted so that it will snap open and closed with good tension and not bind. As stated before, the circuit will remain closed until the clock is wound.

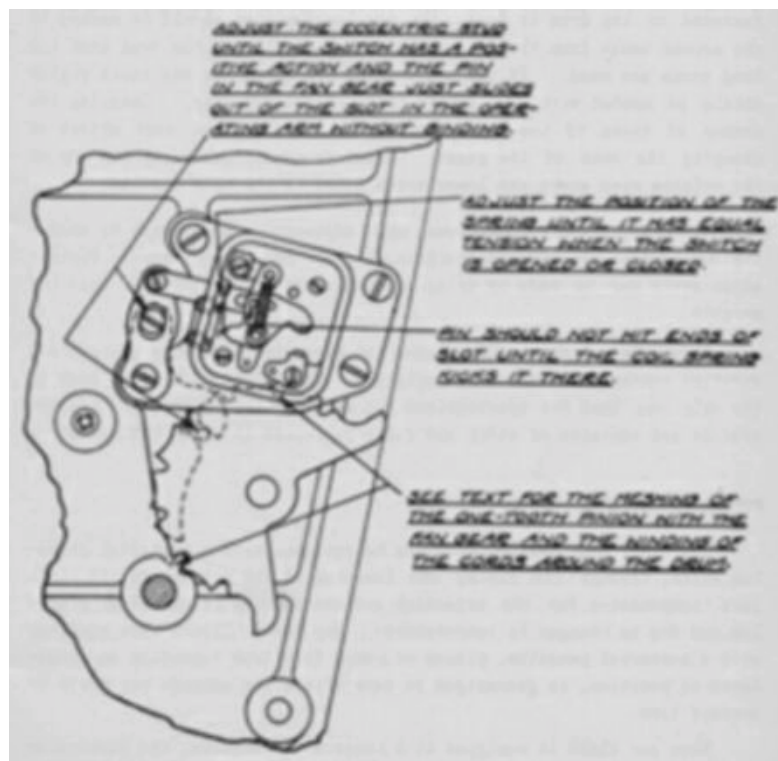

If occasion arises to remove the winding drum from the back frame, care should be taken not to lose the ball bearings and also when reassembling, to get the one tooth pinion meshed properly with the fan gear. When the cords are out full length and the point where they are fastened to the drum is down, the one tooth pinion should be meshed in the second tooth from the end of the fan gear. This holds true when the long cords are used. If the short cords are used, the one tooth pinion should be meshed with the fourth tooth of the fan gear. Changing the number of turns of the cords around the drum has the same effect as changing the mesh of the gears. Under no condition should the top of the weights rise above the lower screw holes in the back casting.

If the weights do not hang even, small adjustments may be made by shifting or bending the support brackets slightly for the pulleys. Further adjustments may be made by tying new knots where the cords go into the weights.

This type of Master Clock uses the same minute impulse contact and duration contact as previously explained. This style of Master Clock is the only one used for synchronized and self regulating systems, the operation and contacts of which are fully explained in other bulletins.

Mercurial Pendulum

Any sixty beat Master Clock may be equipped with a mercurial pendulum which, through the rising and lowering of the mercury in the glass jars, compensates for the expansion and contraction of the steel pendulum rod due to changes in temperature. Any Master Clock, when equipped with a mercurial pendulum, placed on a wall free from vibration and regulated to position, is guaranteed to rate within ten seconds per month of correct time.

When any clock is equipped with a mercurial pendulum, the suspension spring is much heavier to support the extra weight. On a spring driven clock, the main spring is heavier and on a weight driven clock, the weights are heavier as more power is required to swing a mercurial pendulum.

Synchronized Master Clocks

Where it is desired to have two or more master clocks on the same system and each controlling part of the system, as in different buildings or locations, the master clocks may be synchronized with each other. When such is the case, all master clocks except one are termed auxiliary master clocks and are regulated by the one or controlling master clock.

The controlling master clock may be of the hourly supervising type, if impulse equipment is to be operated from it, however, if it is used only for synchronizing other master clocks, it need be only of the plain impulse type.

As each master clock must have its own control equipment, take its power locally, and operate as an independent system, with the exception of the synchronizing feature, any or all master clocks, if they are the weight driven type, may be equipped with an impulse accumulator. Obviously the spring drive master clocks cannot be equipped with an impulse accumulator.

The synchronizing takes place every minute, therefore, the auxiliary master clocks may be of the 120 beat type as even under unusual conditions they would never get over a few seconds from correct time.

The synchronizing consists of an impulse sent out from the controlling master clock each minute. These impulses are received by an electromagnet attached to the auxiliary master clock. Attached to the escape wheel shaft of the auxiliary master clock is a disc with several ratchet teeth cut therein. This disc makes one revolution per minute. When the synchronizing electromagnet receives an impulse its armature is attracted. Attached to the armature is a lever with a flat spring which engages with the ratchet teeth on the disc attached to the escape wheel shaft, stopping same. The auxiliary master clock being regulated to run slightly fast will be stopped for an instant each minute and this keeps it in perfect step with the controlling master clock.

Several teeth are cut in the synchronizing disc to compensate for several seconds error should the synchronizing feature be out of service for long periods of time.

It is obvious from the above that the impulses must not occur oftener than once a minute. For this reason the synchronizing electromagnet can only be connected between the "B" and "C" wires of a supervised circuit, or to a minute impulse system. In the former case the master clock would only be synchronized for 50 minutes each hour. In either case the duration of the synchronizing impulse is approximately two seconds, therefore, the auxiliary master clock will only be corrected at the rate of two seconds per minute and should they be 10 seconds fast, 5 minutes would be required to synchronize them.

The usual application for this plan is to employ a high accuracy [Number] 16-1 Master Clock as a Grand Master to synchronize any number of submasters which we equipped to supervise hourly their respective sub systems of secondary equipment. This plan is used in the Cleveland Terminal Station and the Philadelphia Terminal Station.

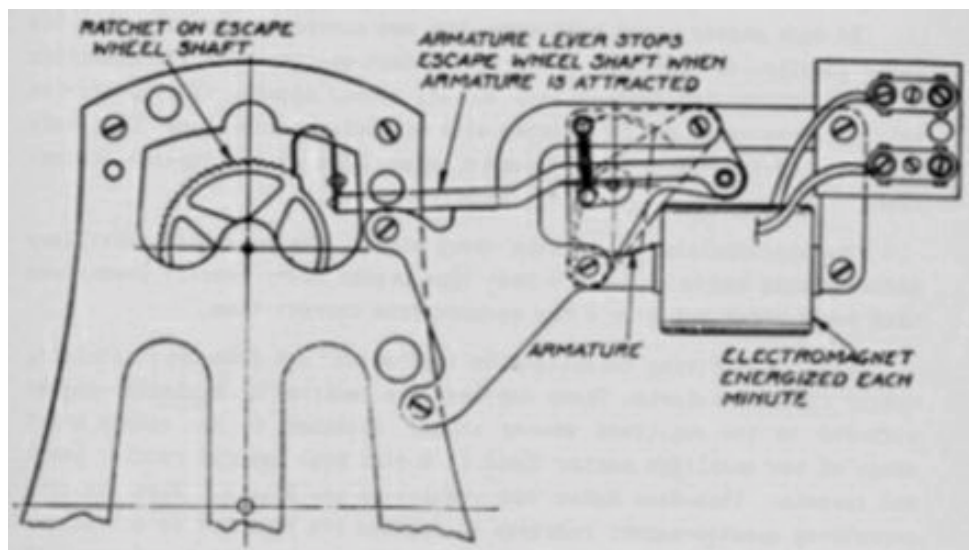

120 Beat Master Clock

The train gears in the 120 beat master clock have been changed in order to use a standard 30 tooth escape wheel and verge such as are used in our 60 beat master clocks. The gear reduction is now twice what it was when a 60 tooth escape wheel was used.

The escape wheel is now mounted to the right of its former location. The larger reduction gear is mounted in the place formerly occupied by the 60 tooth escape wheel. The smaller reduction gear is mounted on the escape wheel shaft. This construction necessitates mounting the verge on its shaft at a different angle in relation to the verge wire and facing in the opposite direction to that generally used on our clocks but the principle of operation and adjustments remain the same.

The above changes enable a heavier pendulum ball to be used which insures more accurate time as it is less influenced by outside or foreign forces.

The verge is now supported by new verge bridges which enable the verge to be adjusted in relation to the escape wheel.

The verge is now equipped with an adjustment which facilitates putting the clock in beat. This consists of a screw adjustment which changes the relation of the verge wire to the verge.

Extreme care must be used when making the contact adjustments on the 120 beat master clock. This is especially so on the seconds and two seconds contact as too much tension may cause the clock to run abnormally fast.

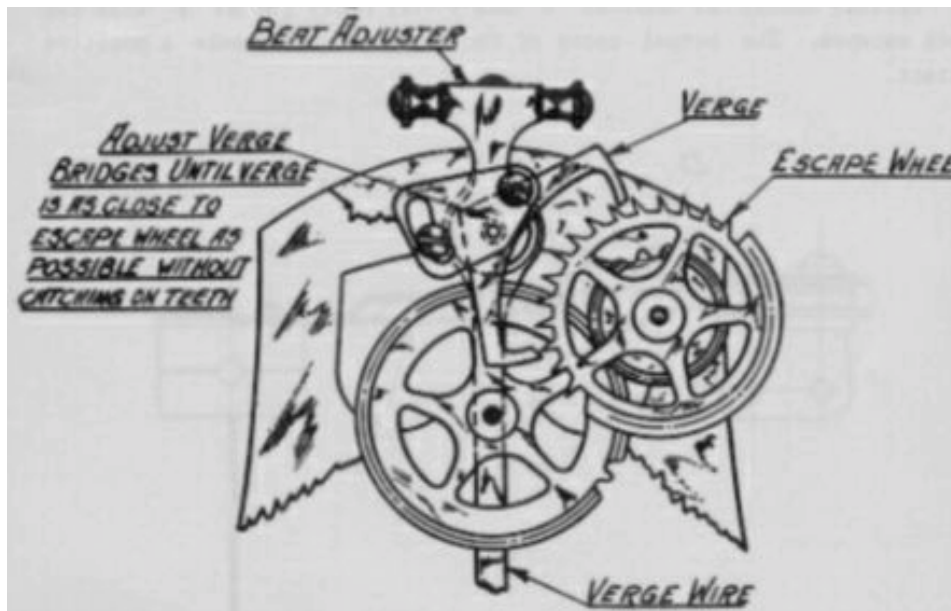

Old Style Rapid Impulse Contacts

The adjustment of the rapid impulse contact has a direct and definite relationship to the timekeeping of the master clock. Once the adjustments are made they will not change but if they are not correctly adjusted the master clock will not give satisfactory results.

Fig. 1 [below] shows the relative position of all parts when the pendulum is at rest.

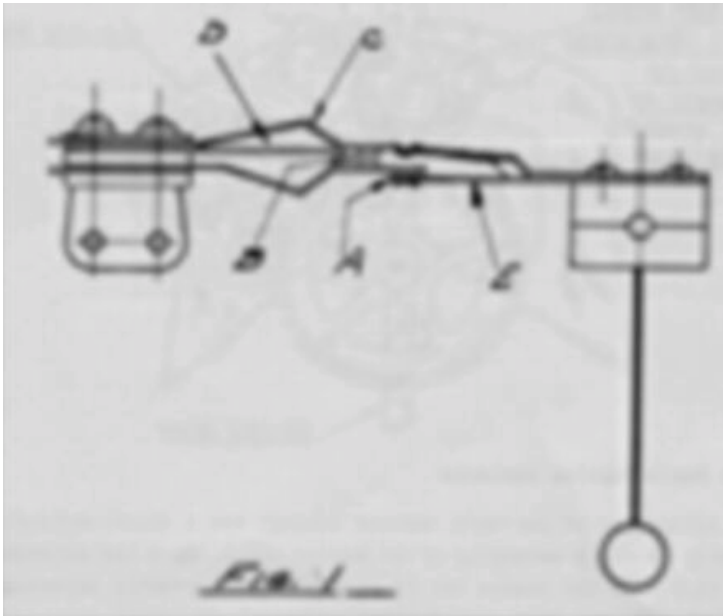

Note that "D" and "E" are approximately parallel. This may be adjusted by changing the relation of "E" to the verge shaft. The contact block assembly may also be adjusted.

Spring "C" should rest on support "D" with just sufficient pressure so that it will follow "D" down about $1/64$ " if "D" is pressed down. More tension than this in spring "C" will do no good and tend to stop the clock.

The contacts should be open at "B" about $1/32$ " when the lower spring is free and not touching anything.

There should be a very small air gap at "A" when the contact is normally open and the pendulum at rest.

Fig. 2 [below] shows the relative position of all parts at the instant of escape when the pendulum swings to the left.

Contact should be made at "G" and a very small gap at "F" when the clock escapes. The normal carry of the pendulum will make a positive contact.

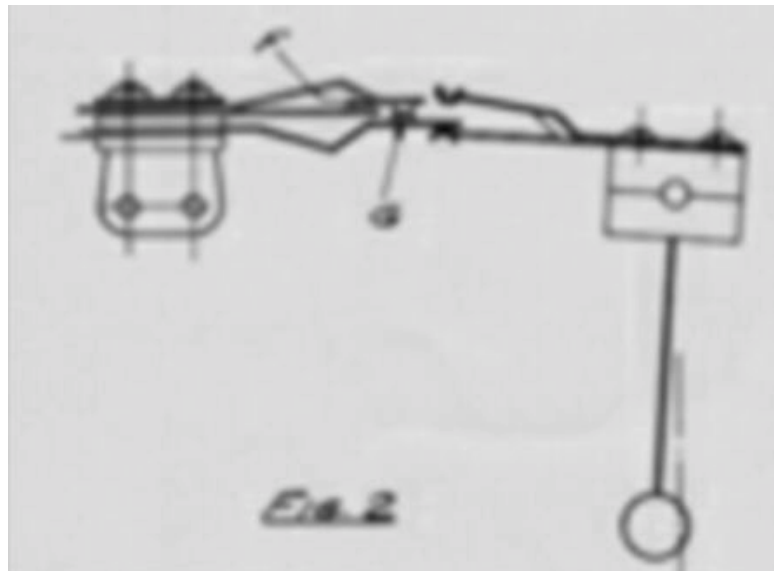
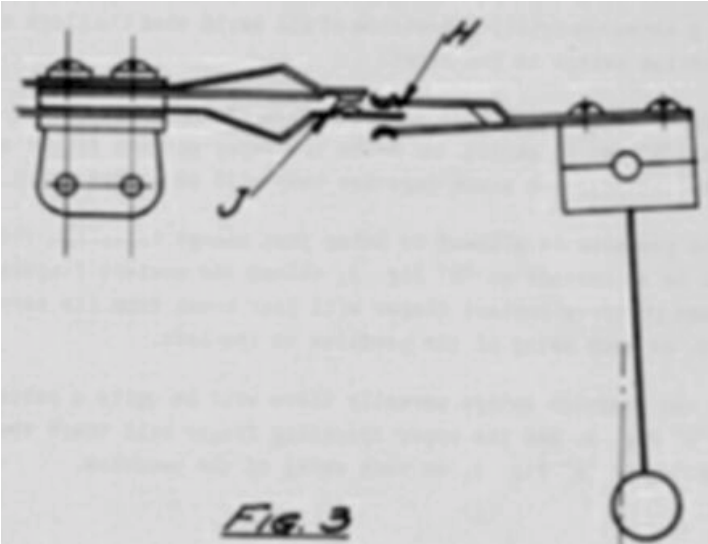

Fig. 3 [below] shows the relative position of all parts when the clock escapes as the pendulum swings to the right.



The upper operating finger should be free of the lower contact finger as shown at “H” but it should be below the upper contact finger so that in case the contacts are stuck together they will be broken apart.

If the pendulum is allowed to swing just enough to escape the clock there will be no contact at “H” [in] Fig. 3, unless the contact fingers stick together and the upper contact finger will just break from its support at “F” [in] Fig. 2, at each swing of the pendulum to the left.

When the pendulum swings normally there will be quite a perceptible break at “F” [in] Fig. 2, and the upper operating finger will touch the lower contact spring at “H” [in] Fig. 3, at each swing of the pendulum.